

H11C1 H11C2 H11C3 H11C4 H11C5 H11C6

PACKAGE DIMENSIONS

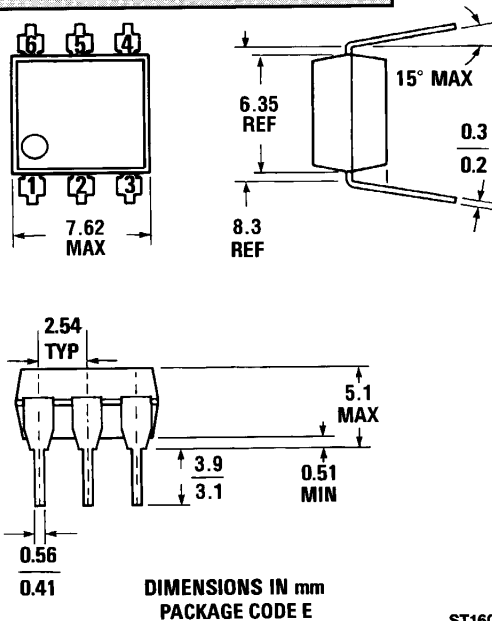

ST1603

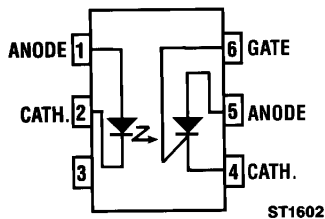

Equivalent Circuit

DESCRIPTION

The H11C series consists of a gallium-arsenide infrared emitting diode optically coupled with a light activated silicon controlled rectifier in a dual-in-line package.

FEATURES & APPLICATIONS

- 10 A, T²L compatible, solid state relay
- 25 W logic indicator lamp driver
- High efficiency, low degradation, liquid epitaxial LED
- 200 V symmetrical transistor coupler (H11C1, H11C2, H11C3)
- 400 V symmetrical transistor coupler (H11C4, H11C5, H11C6)
- Underwriters Laboratory (UL) recognized—File #E90700

ABSOLUTE MAXIMUM RATINGS (T_A=25° unless otherwise specified)

TOTAL PACKAGE

Storage temperature	−55°C to 150°C
Operating temperature	55°C to 100°C
Lead solder temperature	−260°C for 10 sec

INPUT DIODE

Power dissipation	100 mW
Derate linearly (above 25°C)	1.33 mW/°C
Continuous forward current	60 mA
Peak forward current (1 μs pulse, 300 pps)	3 A
Reverse voltage	6 V

DETECTOR

Power dissipation (ambient)	400 mW
Derate linearly (above 25°C ambient)	5.3 mW/°C
Power dissipation (case)	1 W
Derate linearly (above 25°C case)	13.3 mW/°C
Peak reverse gate voltage	6 V
RMS on-state current	300 mA
Peak on-state current (100 μs, 1% duty cycle)	10 A
Surge current (10 ms)	5 A
Peak forward voltage (H11C1, H11C2, H11C3)	200 V
Peak forward voltage (H11C4, H11C5, H11C6)	400 V



PHOTO SCR OPTOCOUPLERS

ELECTRICAL CHARACTERISTICS ($T_A=25^\circ$ Unless Otherwise Specified)

INDIVIDUAL COMPONENT CHARACTERISTICS

PARAMETER	SYMBOL	MIN.	TYP.	MAX.	UNITS	TEST CONDITIONS
INPUT DIODE						
Forward voltage	V_F		1.2	1.5	V	$I_F=10\text{ mA}$
Reverse leakage current	I_R			10	μA	$V_R=3\text{ V}$
Capacitance	C		50		pF	$V=0, f=1\text{ MHz}$
OUTPUT DETECTOR						
Off-state voltage (H11C1, H11C2, H11C3)	V_{DM}	200			V	$R_{GK}=10\text{ k}\Omega, T_A=100^\circ\text{C}, I_R=50\mu\text{A}$
(H11C4, H11C5, H11C6)	V_{DM}	400			V	$R_{GK}=10\text{ k}\Omega, T_A=100^\circ\text{C}, I_R=150\mu\text{A}$
Reverse voltage (H11C1, H11C2, H11C3)	V_{RM}	200			V	$R_{GK}=10\text{ k}\Omega, T_A=100^\circ\text{C}, I_R=50\mu\text{A}$
(H11C4, H11C5, H11C6)	V_{RM}	400			V	$R_{GK}=10\text{ k}\Omega, T_A=100^\circ\text{C}, I_R=150\mu\text{A}$
On-state voltage	V_{TM}		1.1	1.3	V	$I_{TM}=300\text{ mA}$
Off-state current (H11C1, H11C2, H11C3)	I_{DM}			50	μA	$V_{DM}=200\text{ V}, T_A=100^\circ\text{C}, I_F=0, R_{GK}=10\text{ k}\Omega$
(H11C4, H11C5, H11C6)	I_{DM}			150	μA	$V_{DM}=400\text{ V}, T_A=100^\circ\text{C}, I_F=0, R_{GK}=10\text{ k}\Omega$
Reverse current (H11C1, H11C2, H11C3)	I_R			50	μA	$V_R=200\text{ V}, T_A=100^\circ\text{C}, I_F=0$
(H11C4, H11C5, H11C6)	I_R			150	μA	$V_R=400\text{ V}, T_A=100^\circ\text{C}, I_F=0$

TRANSFER CHARACTERISTICS

CHARACTERISTIC	SYMBOL	MIN.	TYP.	MAX.	UNITS	TEST CONDITIONS
Input current to trigger (H11C1, H11C2, H11C4, H11C5)	I_{FT}			20	mA	$V_{AK}=50\text{ V}, R_{GK}=10\text{ k}\Omega$
(H11C3, H11C6)	I_{FT}			30	mA	$V_{AK}=50\text{ V}, R_{GK}=10\text{ k}\Omega$
(H11C1, H11C2, H11C4, H11C5)	I_{FT}			11	mA	$V_{AK}=100\text{ V}, R_{GK}=27\text{ k}\Omega$
(H11C3, H11C6)	I_{FT}			14	mA	$V_{AK}=100\text{ V}, R_{GK}=27\text{ k}\Omega$
Coupled dv/dt, input to output (fig. 13)	dv/dt	500			V/ μs	
Input to output capacitance				2	pF	Input to output voltage=0 $f=1\text{ MHz}$

ISOLATION CHARACTERISTICS

CHARACTERISTIC	SYMBOL	MIN.	TYP.	MAX.	UNITS	TEST CONDITIONS
Surge isolation voltage	V_{ISO}	7500			V	1 Minute
Isolation voltage	V_{ISO}	5300			V	1 Minute
Isolation resistance	R_{ISO}	10^{11}			ohms	$V_{i-o}=500\text{ VDC}$

TYPICAL CHARACTERISTICS

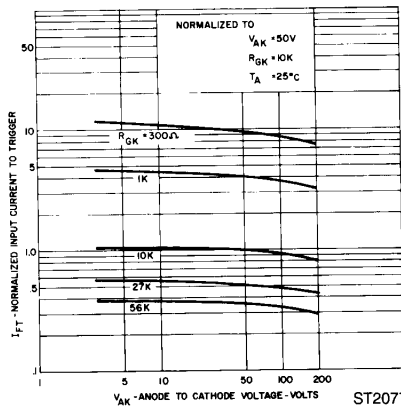

Figure 1. Input Current To Trigger vs. Anode-Cathode Voltage

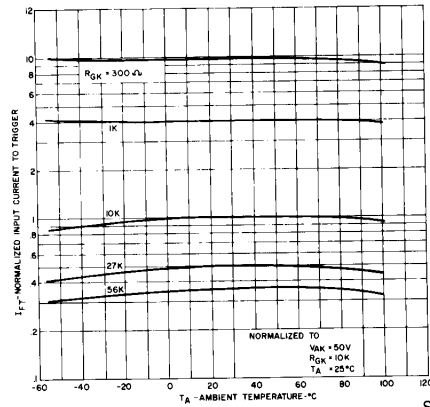

Figure 2. Input Current To Trigger vs. Temperature

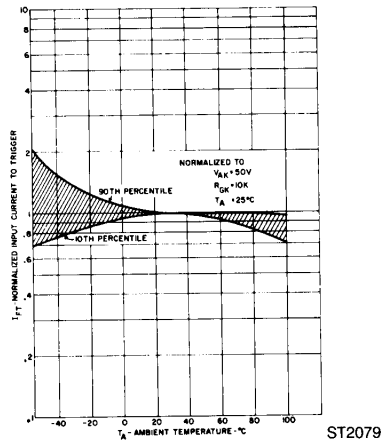

Figure 3. Input Current to Trigger Distribution vs. Temperature

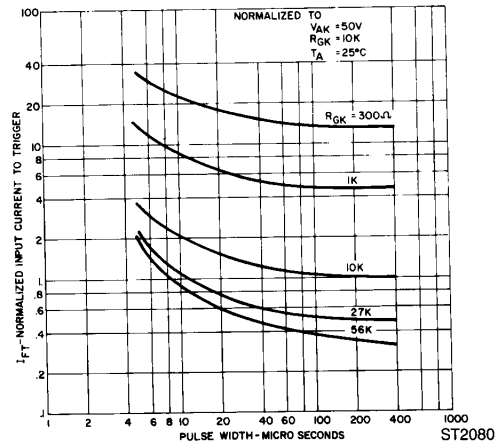

Figure 4. Input Current to Trigger vs. Pulse Width

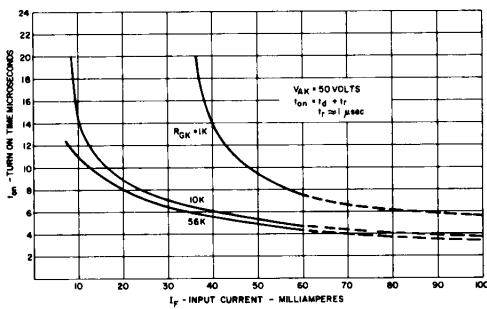

Figure 5. Turn on Time vs. Input Current

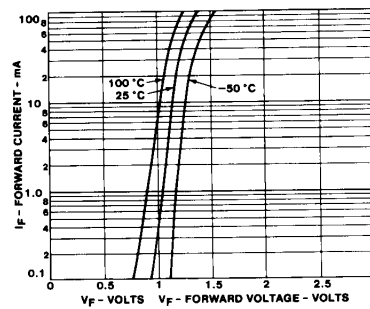

Figure 6. Input Characteristics I_F vs. V_F

TYPICAL CHARACTERISTICS OF OUTPUT (SCR)

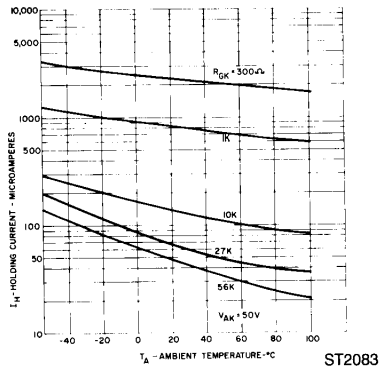

Figure 7. Holding Current vs. Temperature

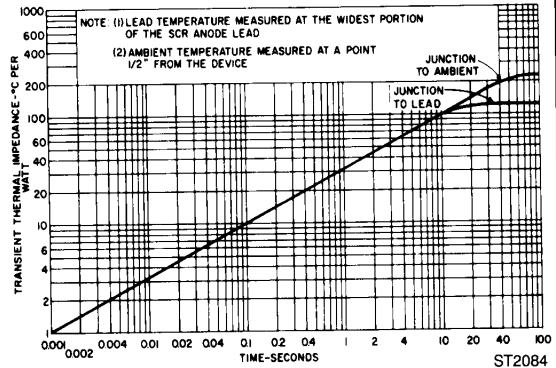

Figure 8. Maximum Transient Thermal Impedance

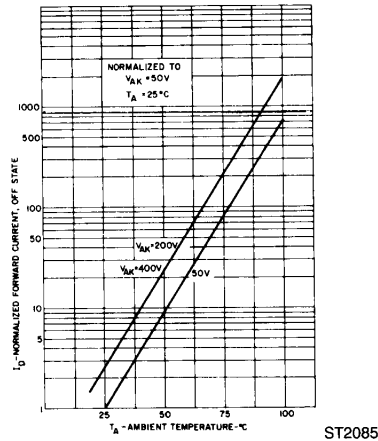

Figure 9. Off State Forward Current vs. Temperature

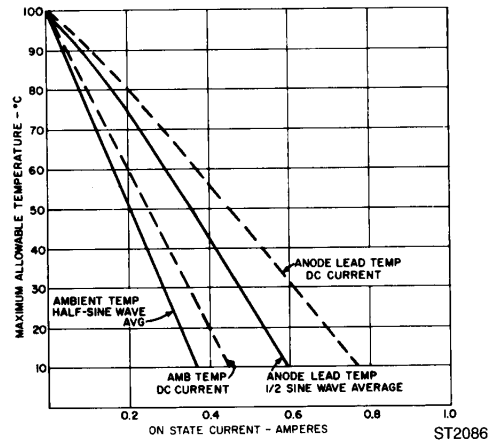

Figure 10. On State Current vs. Maximum Allowable Temperature

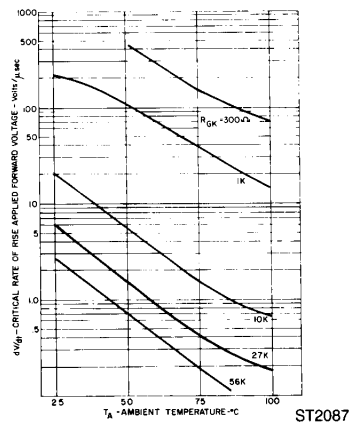

Figure 11. dV/dt vs. Temperature

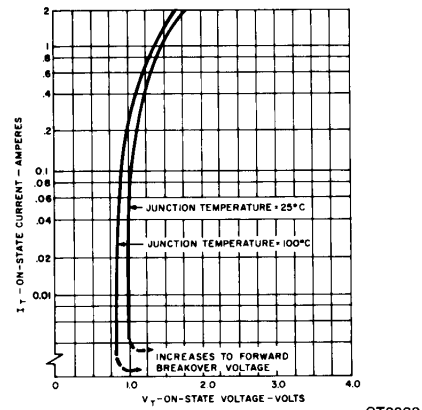
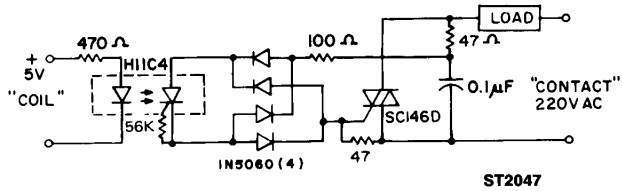

Figure 12. On-State Characteristics

TYPICAL APPLICATIONS

10A, T²L COMPATIBLE, SOLID STATE RELAY

Use of the H11C4 for high sensitivity, 5300V isolation capability, provides this highly reliable solid state relay design. This design is compatible with 74, 74S and 74H series T²L logic systems inputs and 220V AC loads up to 10A.



ST2047

25W LOGIC INDICATOR LAMP DRIVER

The high surge capability and non-reactive input characteristics of the H11C allow it to directly couple, without buffers, T²L and DTL logic to indicator and alarm devices, without danger of introducing noise and logic glitches.

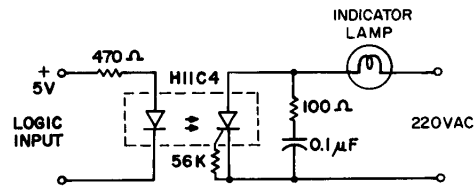

ST2048

400V SYMMETRICAL TRANSISTOR COUPLER

Use of the high voltage PNP portion of the H11C provides a 400V transistor capable of conducting positive and negative signals with current transfer ratios over 1%. This function is useful in remote instrumentation, high voltage power supplies and test equipment. Care should be taken not to exceed the H11C 400 mW power dissipation rating when used at high voltages.

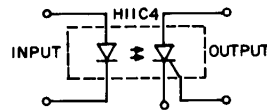

ST2049

Fig 13.
Coupled dV/dt - Test circuit

- $V_p = 800$ Volts
- $t_p = .010$ Seconds
- $f = 25$ Hertz
- $T_A = 25^\circ$ C

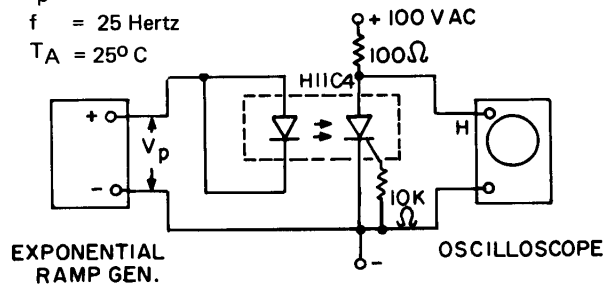
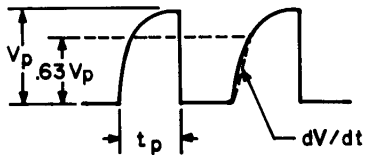

ST2050